

CPX Behälter 1000L rechteckig



Der Behälter hat standardmäßig eine 325-mm-Kontrollöffnung mit O-Ring. Zum Festspannen des Tanks befinden sich auf der Oberseite des Tanks Nuten. Der Behälter kann nach Wunsch mit Anschlüssen versehen werden. Plane Montageflächen für Anschlüsse an den Schmalseiten des Tanks. Wird der Behälter auf die Seite gelegt, passt er durch eine Standardtür von 800 mm Breite.

Art.-Nr.: 21005



Benötigt Einzeltür



Ungefähre Größe

Spezifikationen

Material	PE
Form	Rechteckig
Untere Form	Plan
Leistung	Geschlossen
Art des Deckels	
Farbe	Natürlich
Volumen (L)	1000
Länge (mm)	2268
Breite (mm)	1000
Höhe (mm)	605
Grundfläche (m ²)	2,27
Gewicht (kg)	45
Statistische Zollnummer	3925100000
GTIN	7090046760382
Recycling	

Eigenschaften



Anpassbar



Recyclebar



Großer
Temperaturberei-
ch



Chemikalienbest-
ändig



Dichtigkeitsprüf-
ung



Logistiklösung



An Lebensmittel
angepasst



Einfach zu
reinigen

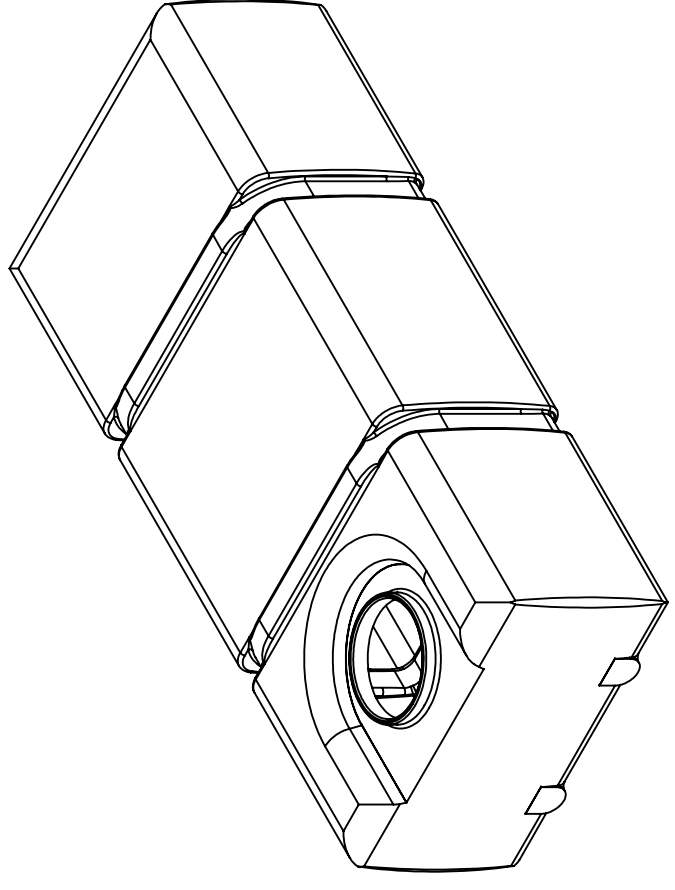
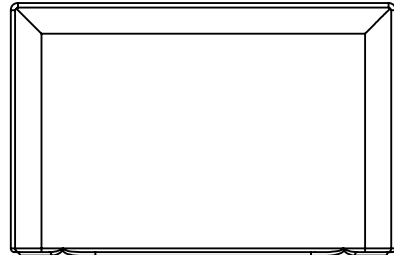
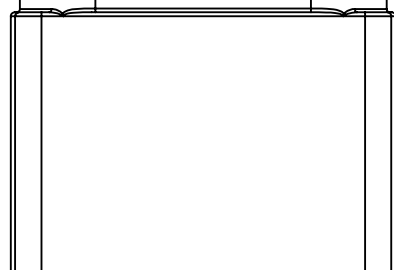
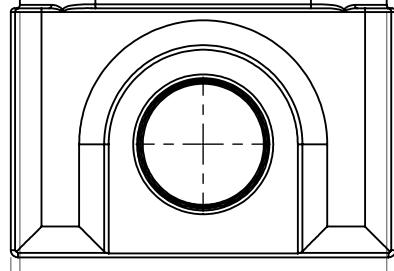
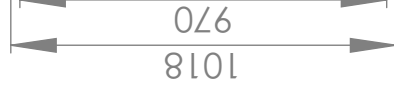
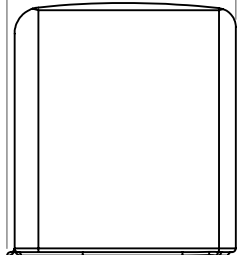
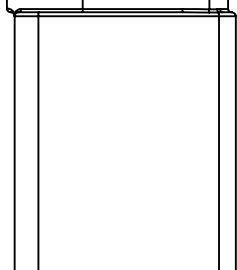
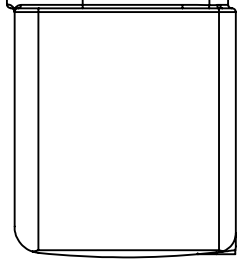
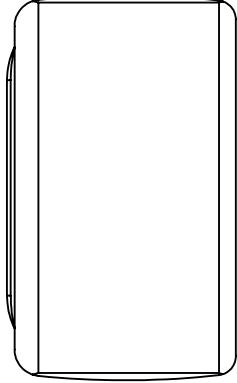
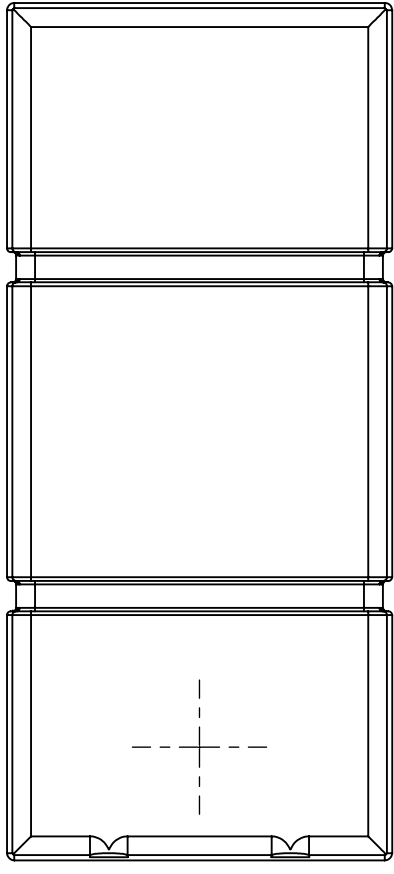

ZO NE	REV.	DESCRIPTION	DATE	APPROVED
	A	New layout	05.11.2013	
	B	Updated to all views	10.09.2020	GEP

REVISIONS

Generelle toleranser om ikke annet oppgitt på tegning	Tilatte avvik for måleområde. Gjelder ved +20°C
General tolerances if not other stated on drawing	Permissible deviations for basic length size range. Valid +20°C
	0-20 ±0.5mm
	>20-75 ±1mm
	>75-150 ±1.5mm
	>150-300 ±1.3%
	>300 ±1%

Constructed by - date	LH	31.03.2009	Evaluated by	GEP	Approved by - date	GEP	10.09.2020	General Tolerances	NS-ISO 2768-1	PE	Finish, Re FINISH AND BREAK SHARP EDGES	View	Scale
Owner													
Title/Description 21005 Container rect. 1000l, 1409431													
Drawing number 513-34													
Revision B													
Sheet size A3													
Sheet 1(1)													