

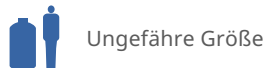

## CPX Lagertank 1800L Schwarz



Der Tank hat eine 600-mm-Einstiegsöffnung mit O-Ring, befestigt am Tank mit einem lackierten Rohrgestell. Auf der Oberseite des Tanks sowie an der unteren Mantelfläche befinden sich vier plane Montageflächen. Bei Bedarf ergänzbar mit einer Schutzwand und passenden Anschlüssen. Für 1,85 Eigengewicht.

Art.-Nr.: 18005



Spezifikationen	
Material	PE
Form	Zylindrisch
Untere Form	Plan
Leistung	Geschlossen
Art des Deckels	
Farbe	Schwarz
Volumen (L)	1800
Höhe (mm)	1585
Durchmesser (mm)	1340
Grundfläche (m <sup>2</sup> )	1,85
Gewicht (kg)	70
Dichtegehalt (max kg / l)	1,85
Statistische Zollnummer	3925100000
Recycling	

## Eigenschaften



Anpassbar



Recyclebar



Großer  
Temperaturbereich



Chemikalienbeständig



Dichtigkeitsprüfung



Logistiklösung



An Lebensmittel angepasst



Einfach zu reinigen

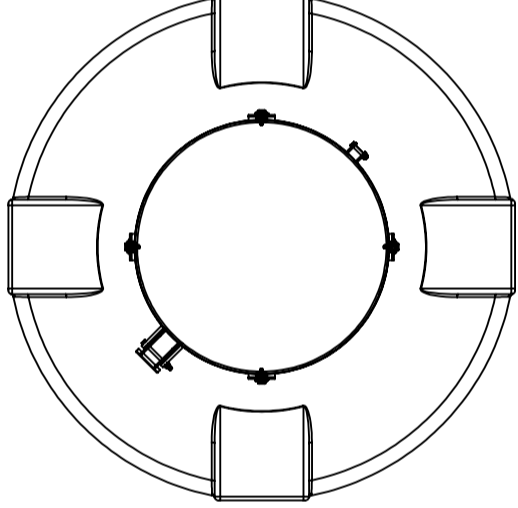
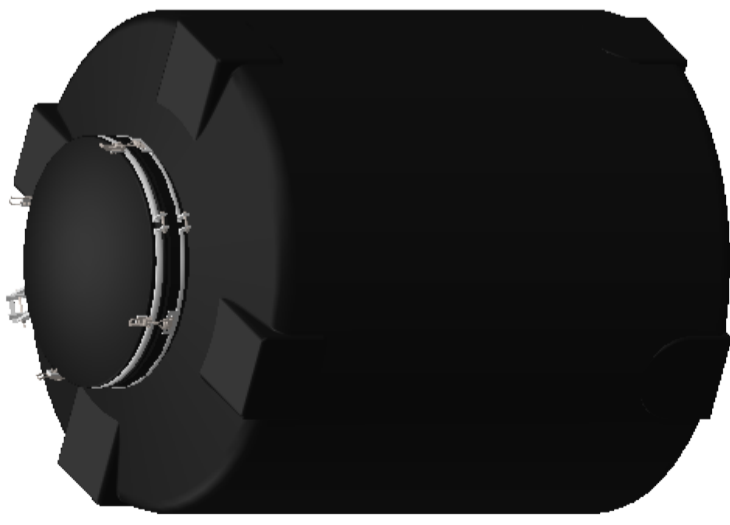
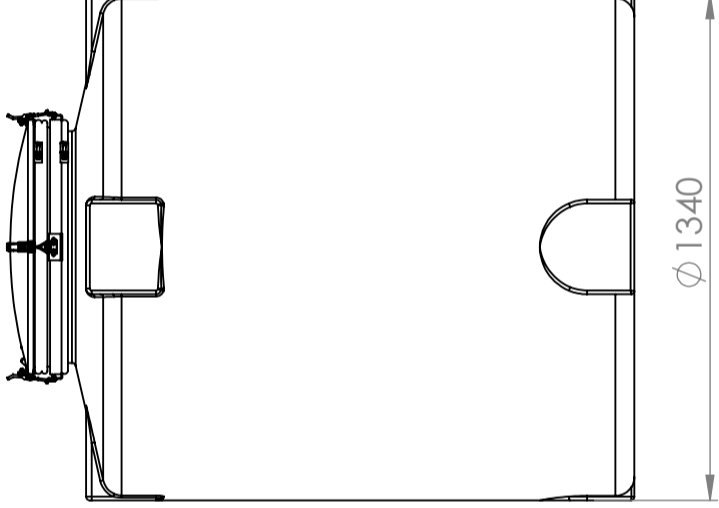
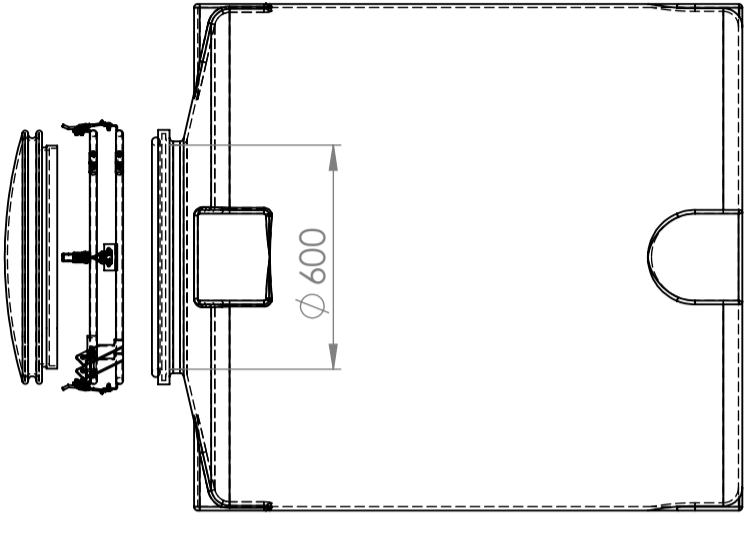
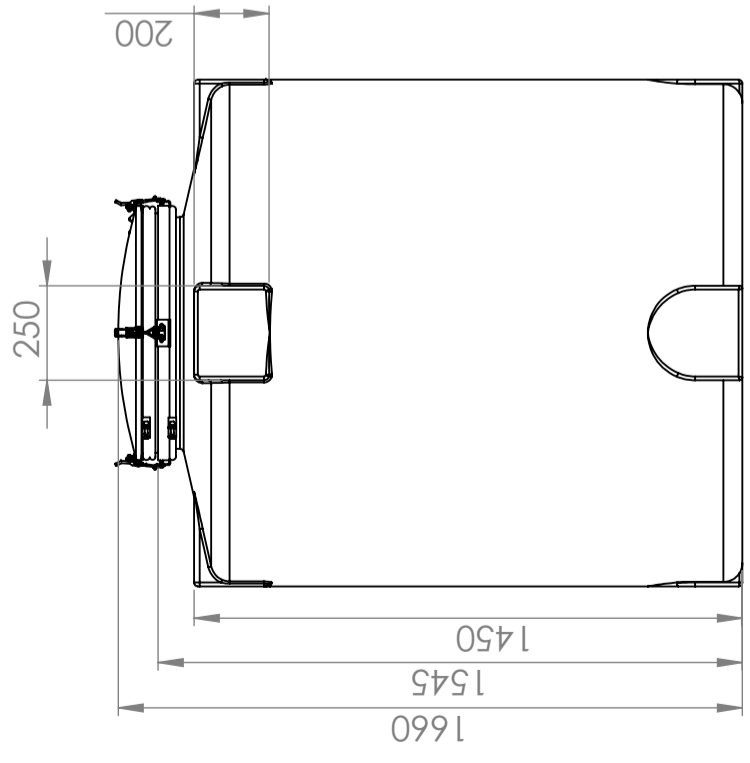

For tare weight 1.85 kg/dm<sup>3</sup>

\*Manhole requires 800mm space to fully open compared to maximum height.

Generelle toleranser om ikke annet oppgitt på tegning				Tilatte avvik for måleområde. Gjelder ved +20°C			
General tolerances if not other stated on drawing				Permissible deviations for basic length size range. Valid +20°C			
0-20	>20-75	>75-150	>150-300	>300			
±0.5mm	±1mm	±1.5mm	±1.3%	±1%			

Constructed by - date	Evaluated by	Approved by - date	General Tolerances	Finish, Ra	View	Scale
GEP 17.01.2024			NS-ISO 2768-1	PE		1:20
Owner			Title/Description			
CIPAX			18005 CPX Storage tank 1800L black			
Drawing number			Revision		Sheet	
1425 - 314					A3 1(2)	