

CPX Kandiline mahuti 1000 liitrit



Mahuti standardvarustuses on rõngastihendiga 325 mm kaas. Mahuti hõlpsaks kinnitamiseks on selle peal kinnitusrihmade jaoks sooned. Mahutile saab soovi korral ühendusi paigaldada. Ühetasased pinnad ühenduste paigaldamiseks paagi lühikestele külgedele. Külili asetatud mahuti saab lükata läbi 800 mm standarddukse.

Art.nr: 21005



Nõuab ühe ukse olemasolu



Ligikaudne suurus

Spetsifikatsioonid

Materjal	PE
Vorm	Ristkülikukujuline
Põhja kuju	Sirge
Mudel	Suletud
Kaane tüüp	
Värv	Loomulik
Maht (L)	1000
Pikkus (mm)	2268
Laius (mm)	1000
Kõrgus (mm)	605
Põrandapind (m ²)	2,27
Kaal (kg)	45
Tiheduse sisaldus (max kg/l)	1,2
Tollistatistika number	3925100000
GTIN	7090046760382
Taaskasutus	

Omadused



Kohaldatavad tooted



Taaskasutatav



Lai temperatuuriva hemik



Kemikaalidele vastupidav



Lekkekindel



Logistika lahendused



Lubatud kokkupuude toiduga



Tooteid on lihtne puhastada

Trükitud 03.07.2024

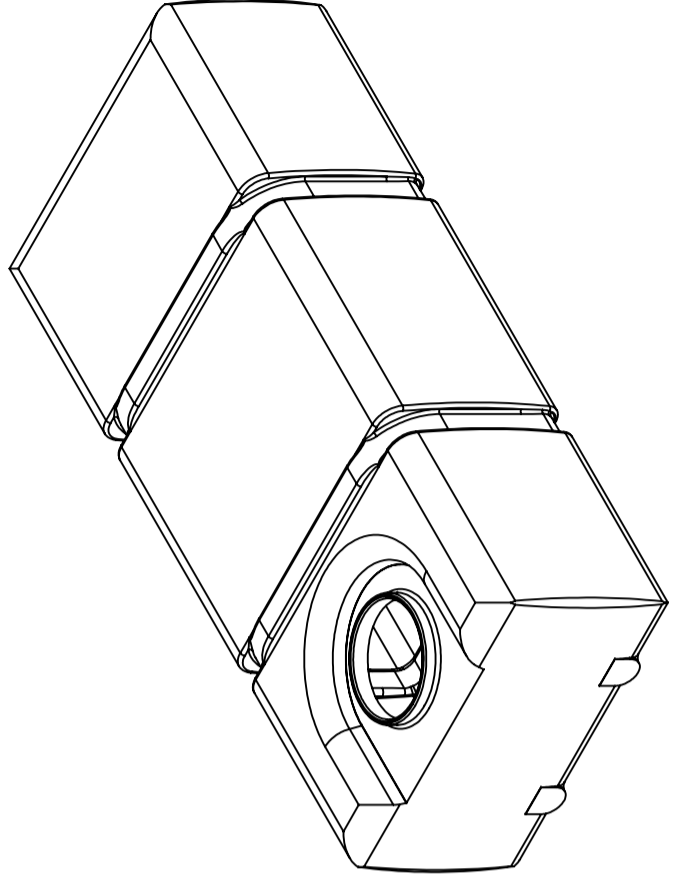
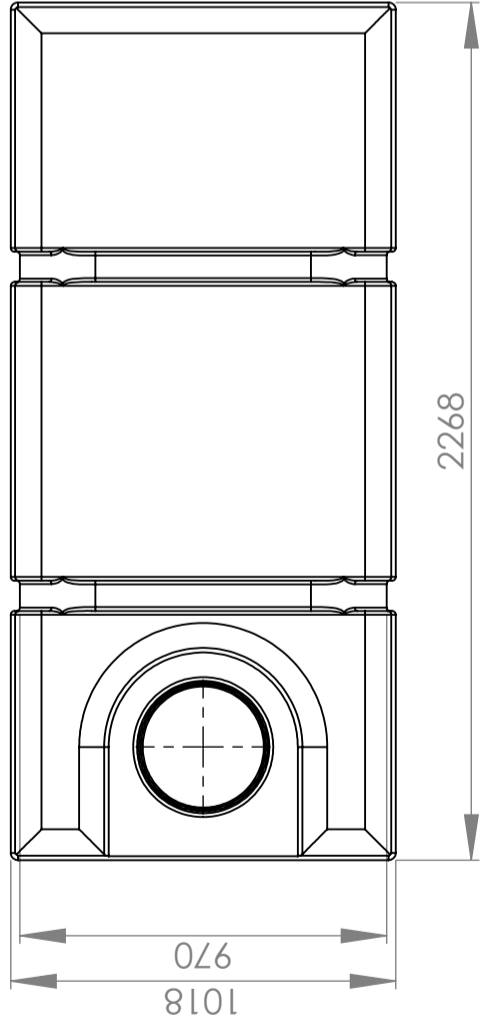
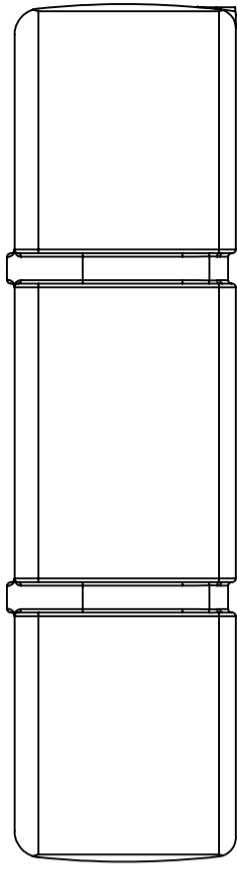
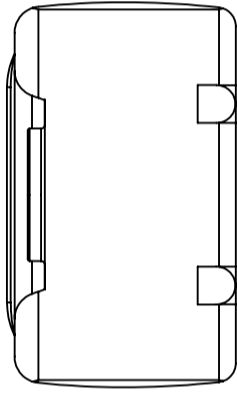
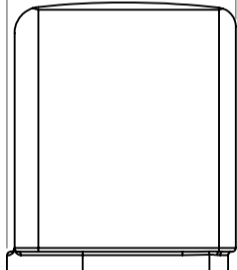
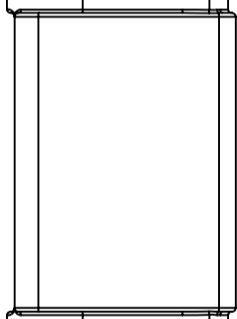
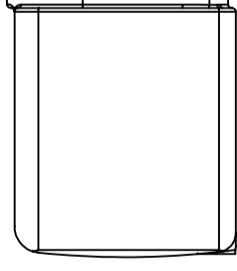
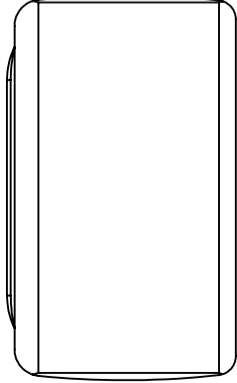
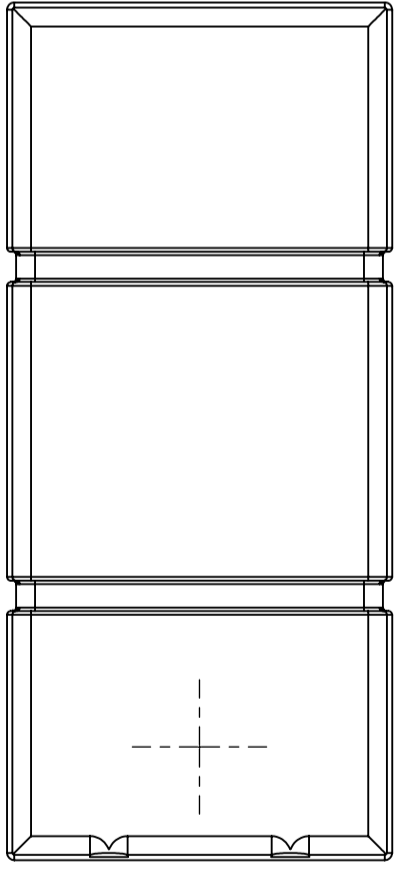

ZO NE	REV.	DESCRIPTION	DATE	APPROVED
	A	New layout	05.11.2013	
	B	Updated to all views	10.09.2020	GEP

REVISIONS

Generelle toleranser om ikke annet oppgitt på tegning	Tilatte avvik for måleområde. Gjelder ved +20°C
General tolerances if not other stated on drawing	Permissible deviations for basic length size range. Valid +20°C
	0-20 ±0.5mm
	>20-75 ±1mm
	>75-150 ±1.5mm
	>150-300 ±1.3%
	>300 ±1%

Constructed by - date	LH	31.03.2009	Evaluated by	GEP	Approved by - date	GEP	10.09.2020	General Tolerances	NS-ISO 2768-1	PE	Finish, Re FINISH AND BREAK SHARP EDGES	View	Scale
Owner	CIPAX												
Titel/Description	21005 Container rect. 1000l, 1409431												
Drawing number	513-34												
Revision	B												
Sheet size	A3												
Sheet	1(1)												