



CPX Suorakaiteen muotoiset sailiot 310L

Container adapted to fit half EUR pallet with pallet sides.
Space for loading straps on container top.

Art.nr: 20310



Vaatii yhden oven



Arvioitu koko

Tekniset tiedot

Materiaali	PE
Muoto	Suorakulmainen
Pohjan muoto	Suoraan
Esitys	Suljettu
Kansityyppi	
Väri	Luonnollinen
Tilavuus (L)	310
Pituus (mm)	735
Leveys (mm)	540
Korkeus (mm)	930
Pinta-ala (m ²)	0,4
Paino (kg)	25
Tiheyspitoisuus (max kg/l)	1,2
Tullitilastojen numero	3925100000
Pakkaus	4 s / pall
Kierrätys	

Ominaisuudet



Säiliöt voidaan varustaa yhteillä



Kierrätettävä materiaali



Laaja lämpötila-alue



Hyvä kemikaali- ja korroosiokestävyys



Tiiveystestaus



Logistiikkaratkaisut



Elintarvikehyväksyntä



Tuotteet on helppo puhdistaa

Painettu 19.1.2025

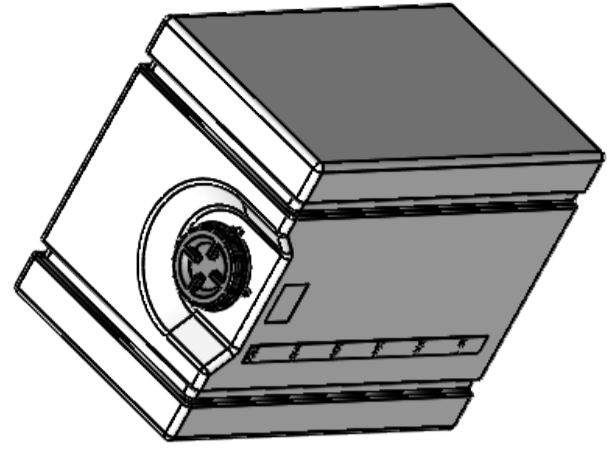
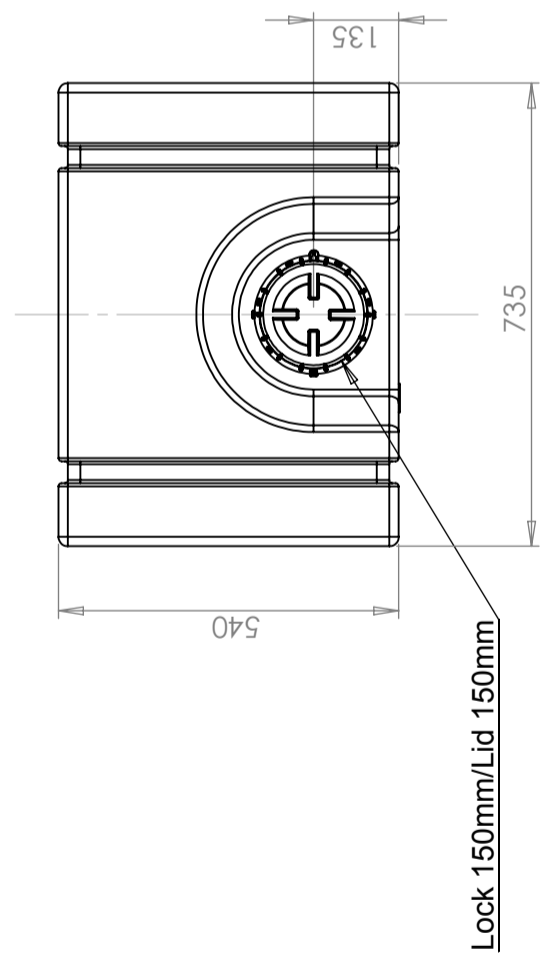
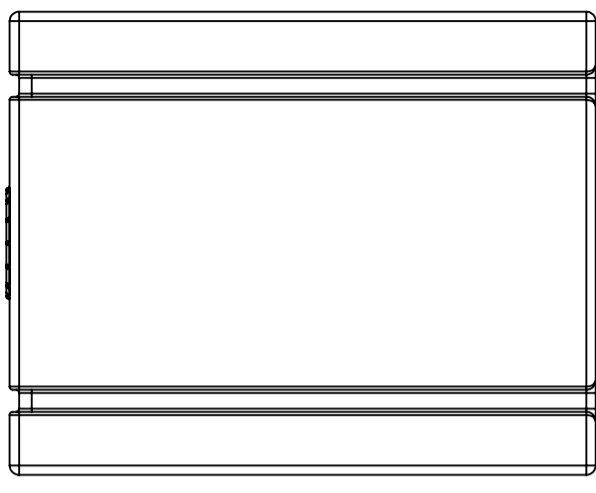
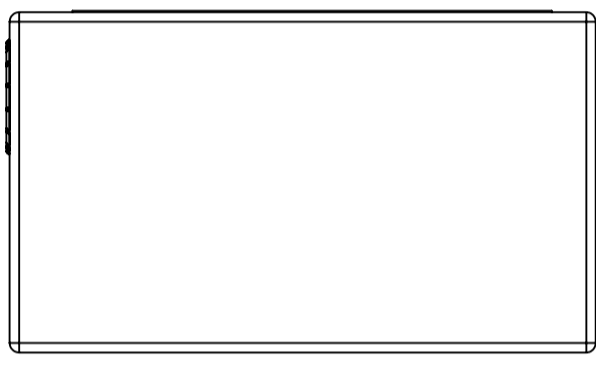
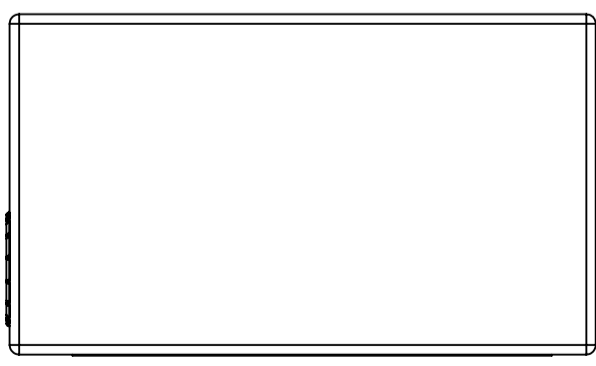
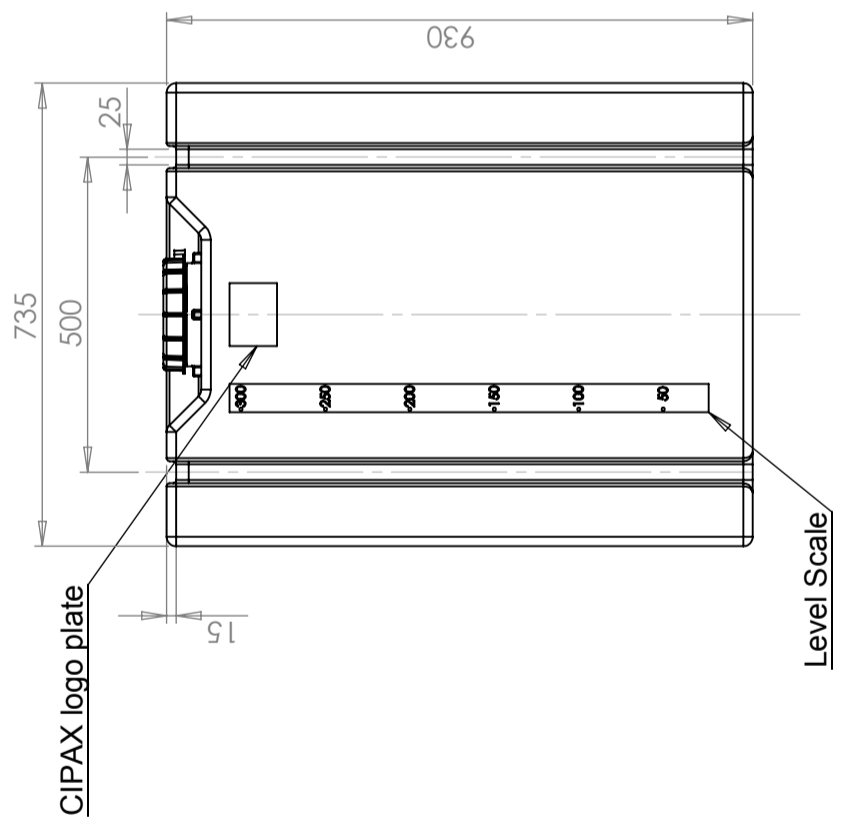
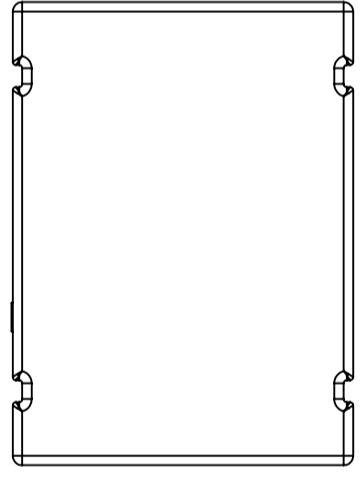

Material: polyethene, white

Konstruerad av JA	Granskad av JA	Godkänd av - datum JA - 2013-11-14	Generell tolerans SS-ISO 2768-1	Generell Ytjämnhet, Ra	Vyplacering 	Skala 1:12
-----------------------------	--------------------------	--	------------------------------------	---------------------------	-----------------	----------------------

Ägare	Titel/Benämning Rektangulär behållare 310 L	Blad 1(1)
	Ritningsnummer 20310	Utgåva



Generella toleranser om ej annat anges på ritning General tolerances if not other stated on drawing	Tillåtna avvikelser för längdbasmåttområde Permissible deviations for basic length size range	0-20	>20-75	>75-150	>150-300	>300
		± 0,5 mm	± 1 mm	± 1,5 mm	± 1,3 %	± 1 %

This drawing and design is the property of CIPAX. Copying and distribution of the drawing or any contents is prohibited without written permission from authorised personal at CIPAX