

## CPX Container 1000L rechthoekig



De container beschikt standaard over een met een O-ring afgedicht mangat van 325 mm. Om de tank eenvoudig vast te kunnen zetten, zitten er groeven voor spanbanden aan de bovenkant van de tank. De container kan worden voorzien van aansluitingen, geheel volgens uw wensen. Vlakke oppervlakken voor montage van aansluitingen aan de korte zijden van de tank. Door de container op zijn kant te leggen, past die door een standaarddeur van 800 mm.

Art.nr.: 21005



Vereist enkele  
deur



Grootte ongeveer

### Specificaties

Materiaal	PE
Model	Rechthoekig
Bodem	Vlak
Uitvoering	Gesloten
Type deksel	
Kleur	Naturel
Inhoud (L)	1000
Lengte (mm)	2268
Breedte (mm)	1000
Hoogte (mm)	605
Vloeroppervlak (m2)	2,27
Gewicht (kg)	45
Statistisch nummer van de douane	3925100000
GTIN	7090046760382
Recycling	

### Eigenschappen



Aanpasbaar



Recyclebaar



Breed  
temperatuurbereik:



Bestand tegen  
chemicaliën



Lek testen



Logistieke  
oplossing



Aangepast voor  
eten



Makkelijk  
schoon te  
maken

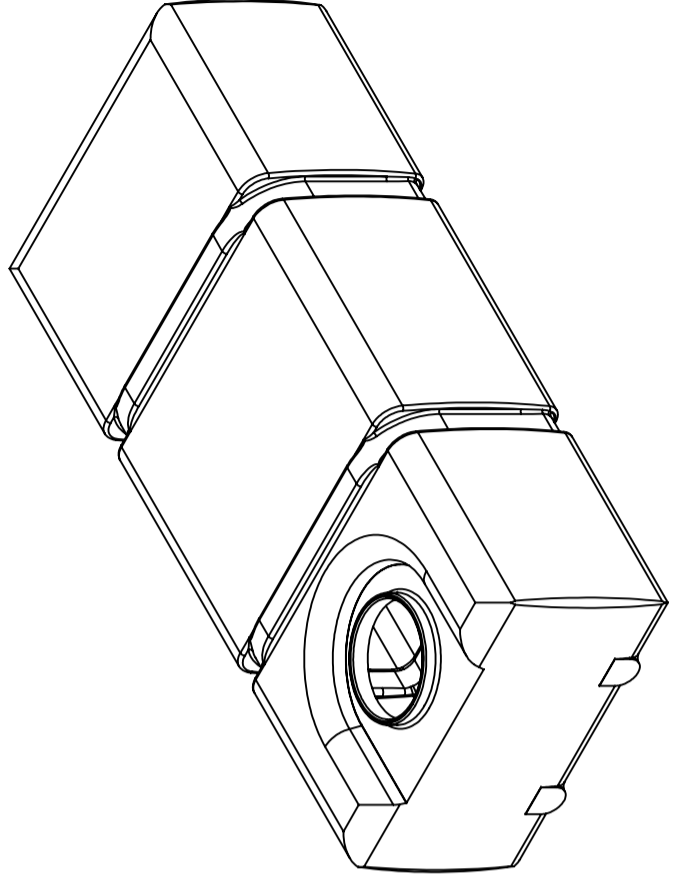
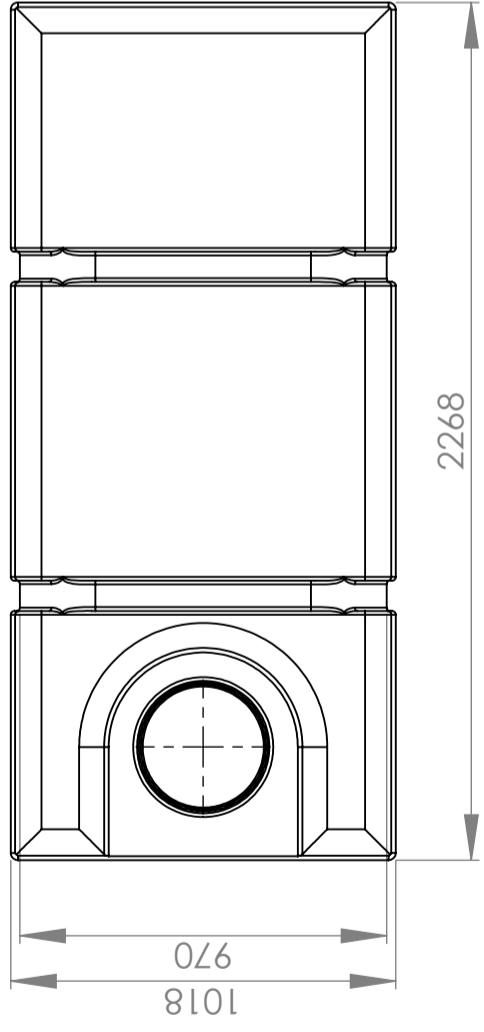
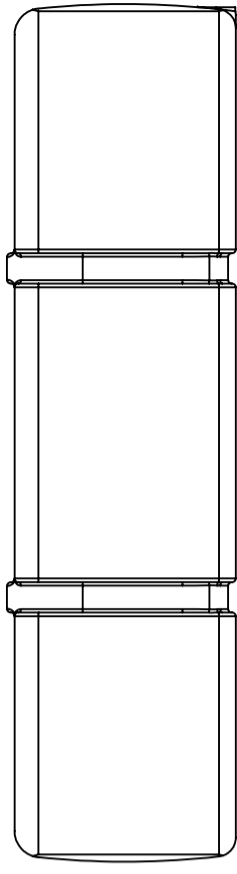
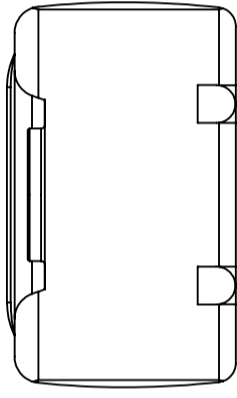
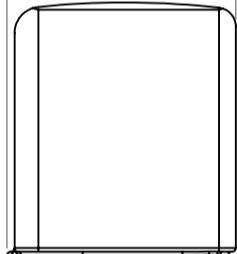
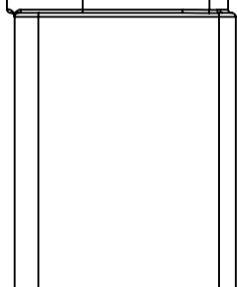
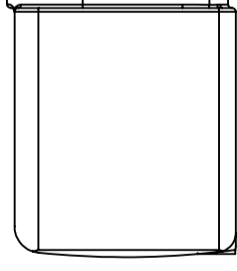
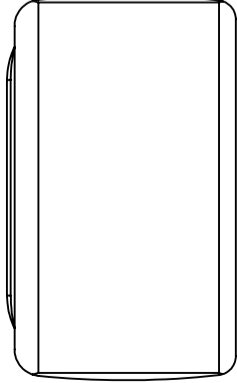
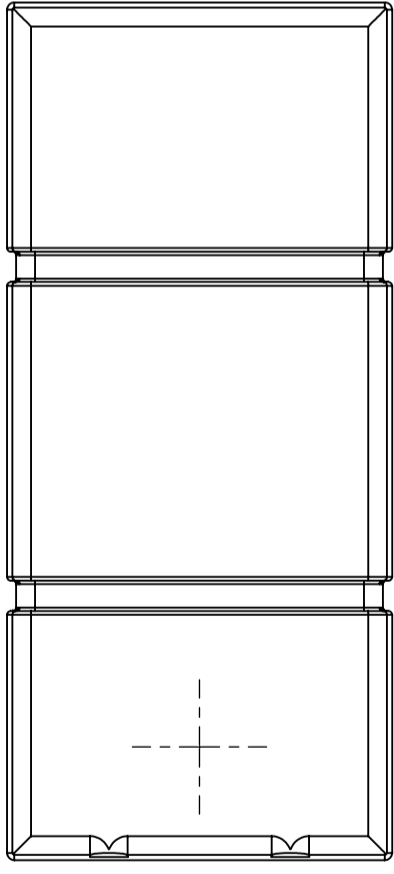

ZO NE	REV.	DESCRIPTION	DATE	APPROVED
	A	New layout	05.11.2013	
	B	Updated to all views	10.09.2020	GEP

REVISIONS

Generelle toleranser om ikke annet oppgitt på tegning	Tilatte avvik for måleområde. Gjelder ved +20°C
General tolerances if not other stated on drawing	Permissible deviations for basic length size range. Valid +20°C
	0-20 ±0.5mm
	>20-75 ±1mm
	>75-150 ±1.5mm
	>150-300 ±1.3%
	>300 ±1%

Constructed by - date	LH	31.03.2009	Evaluated by	GEP	Approved by - date	GEP	10.09.2020	General Tolerances	NS-ISO 2768-1	PE	Finish, Re FINISH AND BREAK SHARP EDGES	View	Scale
Owner	CIPAX												
Titel/Description	21005 Container rect. 1000l, 1409431												
Drawing number	513-34												
Revision	B												
Sheet size	A3												
Sheet	1(1)												