

CPX Container 310L rechthoekig



De container heeft standaard een O-ring verzegelde schroefdop van 150 mm. De schroefdop is goed beschermd aan de bovenkant van de tank en kan worden voorzien van een slot (accessoire). Om de tank eenvoudig vast te kunnen zetten, zitten er twee groeven voor spanbanden aan de bovenkant en de zijkanten van de tank. De container kan naar wens worden voorzien van aansluitingen. De bovenkant van de container is belastbaar, bijv. voor een doseerpomp. De tank is aangepast om te passen binnen de palletranden van een halve EUR-pallet. Op een EUR-pallet passen twee containers binnen de palletranden.

Art.nr.: 20310



Vereist enkele
deur



Grootte ongeveer

Specificaties

Materiaal	PE
Model	Rechthoekig
Bodem	Vlak
Uitvoering	Gesloten
Type deksel	
Kleur	Naturel
Inhoud (L)	310
Lengte (mm)	735
Breedte (mm)	540
Hoogte (mm)	930
Vloeroppervlak (m ²)	0,4
Gewicht (kg)	25
Statistisch nummer van de douane	3925100000

Recycling



Eigenschappen



Aanpasbaar



Recyclebaar



Breed
temperatuurber
eik:



Bestand tegen
chemicaliën



Lek testen



Logistieke
oplossing



Aangepast voor
eten



Makkelijk
schoon te
maken

Gedrukt 03-05-2024

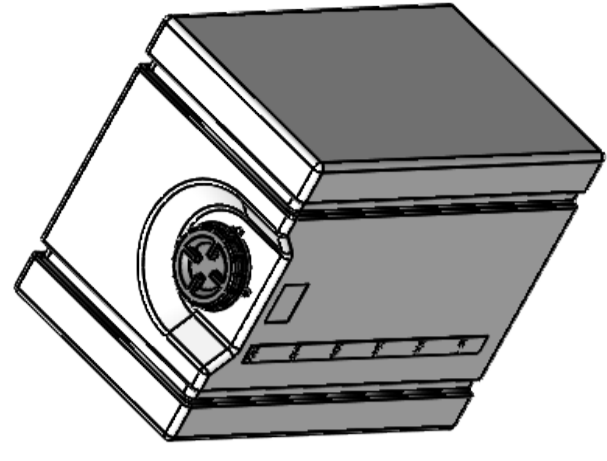
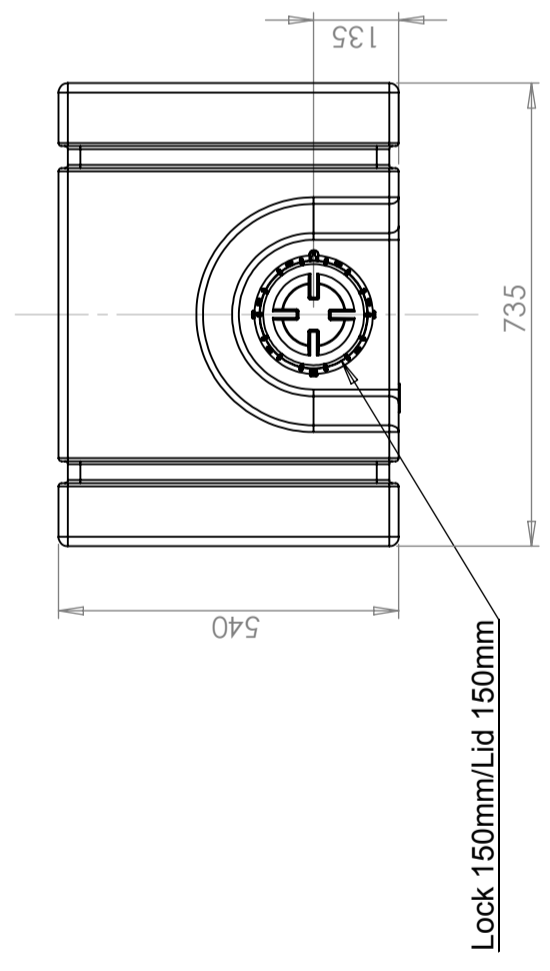
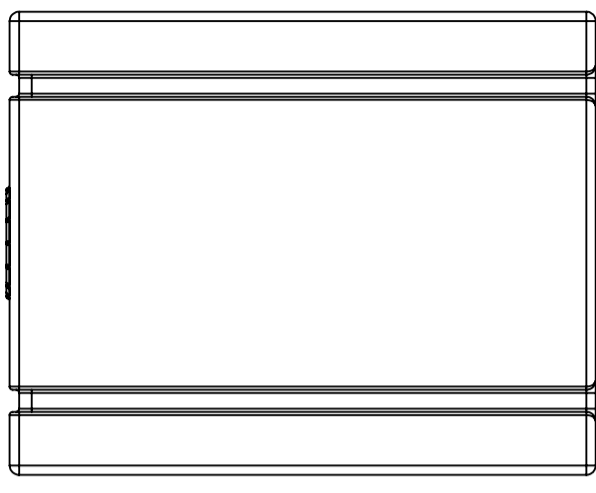
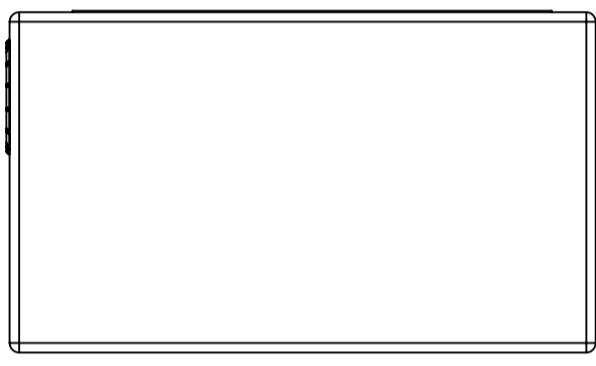
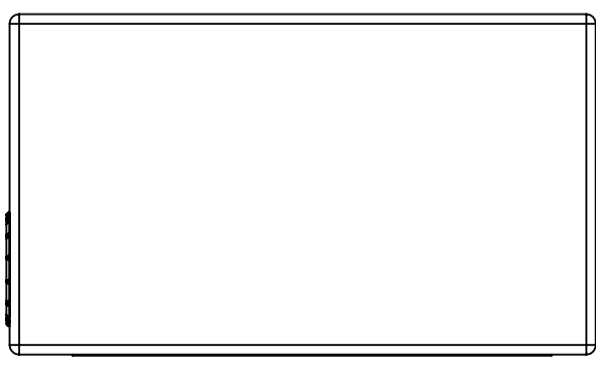
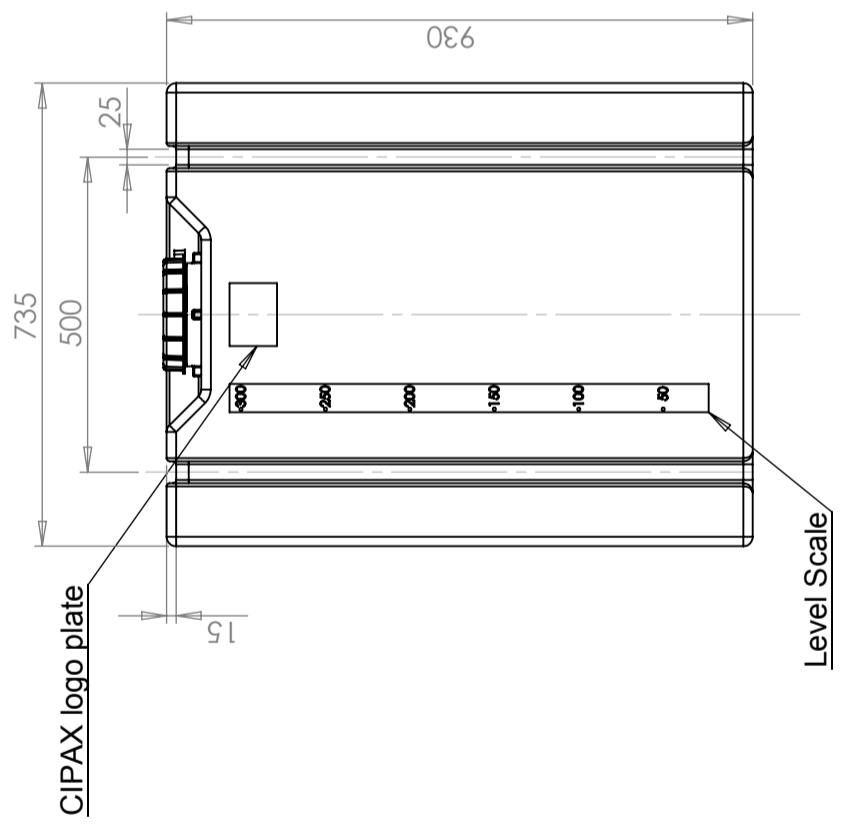
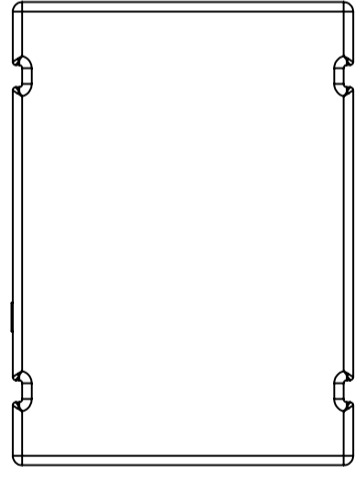

Material: polyethene, white

Konstruerad av	Granskad av	Godkänd av - datum	Generell tolerans	Generell Ytjämnhet, Ra	Vyplacering	Skala
JA	JA	JA - 2013-11-14	SS-ISO 2768-1			1:12

Ägare	Titel/Benämning		Blad
	Rektangulär behållare 310 L		1(1)
	Ritningsnummer	Utgåva	
	20310		



Generella toleranser om ej annat anges på ritning General tolerances if not other stated on drawing	Tillåtna avvikelser för längdbasmåttområde Permissible deviations for basic length size range			
	0-20	>20-75	>75-150	>150-300
	± 0,5 mm	± 1 mm	± 1,5 mm	± 1,3 %
				>300 ± 1 %

This drawing and design is the property of CIPAX. Copying and distribution of the drawing or any contents is prohibited without written permission from authorised personal at CIPAX