

CPX Behållare 1000L rektangulär



Behållaren har en o-ringstättad 325 mm manlucka som standard. För att enkelt kunna spänna fast tanken finns spår för spännband på tankens topp. Behållaren kan förses med anslutningar enligt önskemål. Plana ytor för montering av anslutningar på tankens kortsidor. Genom att lägga behållaren på sidan kan den skjutas igenom en standarddörr 800 mm.

Art.nr: 21005



Kräver enkeldörr



Ungefärlig storlek

Specifikationer

Material	PE
Form	Rektangulär
Bottenform	Plan
Utförande	Sluten
Typ av lock	320mm O-ringstättad manlucka
Färg	Naturell
Volym (L)	1000
Längd (mm)	2268
Bredd (mm)	1000
Höjd (mm)	605
Golvyta (m2)	2,27
Vikt (kg)	45
Densitet innehåll (max kg/l)	1,2
Tullstatistiskt nummer	3925100000
GTIN	7090046760382
Klimatpåverkan (kg CO2-ekv.)	111

Återvinning



Egenskaper



Anpassningsbar



Återvinningsbar



Brett
temperaturspann



Kemikalieresistens



Läcktestning



Logistiklösning



Anpassad för
livsmedel



Enkel att
rengöra

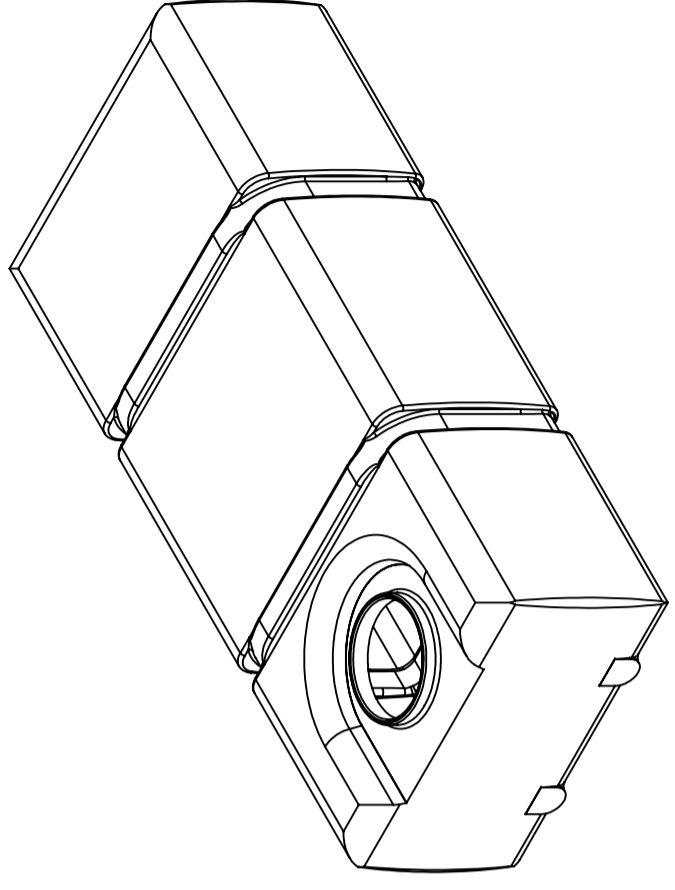
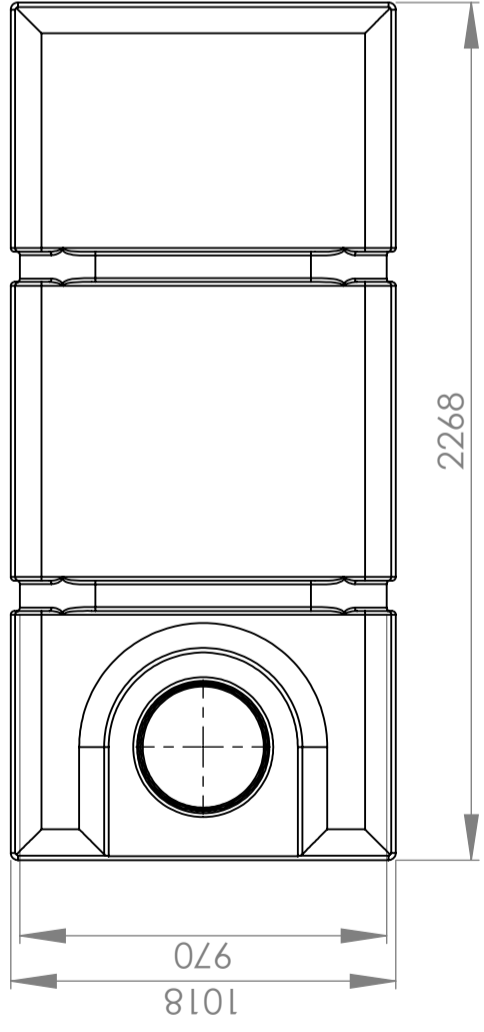
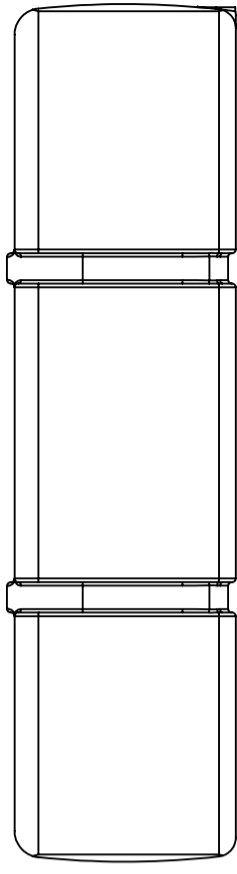
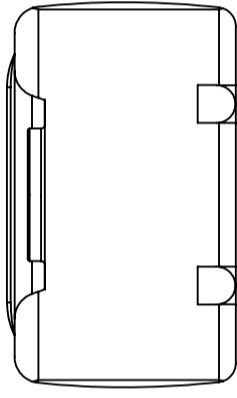
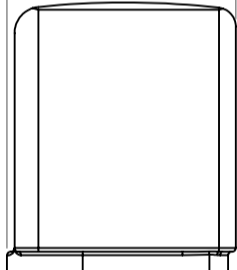
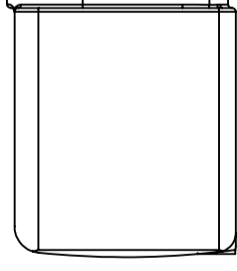
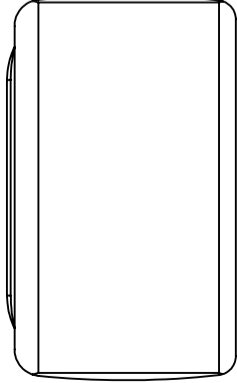
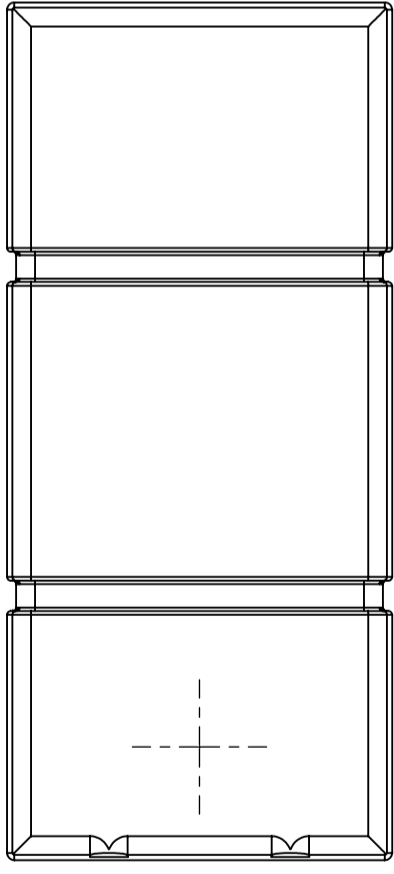

ZO NE	REV.	DESCRIPTION	DATE	APPROVED
	A	New layout	05.11.2013	
	B	Updated to all views	10.09.2020	GEP

REVISIONS

Generelle toleranser om ikke annet oppgitt på tegning	Tilatte avvik for måleområde. Gjelder ved +20°C
General tolerances if not other stated on drawing	Permissible deviations for basic length size range. Valid +20°C
	0-20 ±0.5mm
	>20-75 ±1mm
	>75-150 ±1.5mm
	>150-300 ±1.3%
	>300 ±1%

Constructed by - date	LH	31.03.2009	Evaluated by	GEP	Approved by - date	GEP	10.09.2020	General Tolerances	NS-ISO 2768-1	PE	Finish, Re FINISH AND BREAK SHARP EDGES	View	Scale
Owner	CIPAX												
Titel/Description	21005 Container rect. 1000l, 1409431												
Drawing number	513-34												
Revision	B												
Sheet size	A3												
Sheet	1(1)												