



## CPX Behållare 310L rektangulär

Behållare anpassad för att kunna användas på halvpall med pallkragar. Plats för spännband på behållaren topp.

Art.nr: 20310



Kräver enkeldörr



Ungefärlig storlek

### Specifikationer

Material	PE
Form	Rektangulär
Bottenform	Plan
Utförande	Sluten
Typ av lock	150mm O-ringstättad skruvlock
Färg	Naturell
Volym (L)	310
Längd (mm)	735
Bredd (mm)	540
Höjd (mm)	930
Golvyta (m2)	0,4
Vikt (kg)	25
Densitet innehåll (max kg/l)	1,2
Tullstatistiskt nummer	3925100000
Leveransförpackning	4 st/pall
Klimatpåverkan (kg CO2-ekv.)	63

Återvinning



### Egenskaper



Anpassningsbar



Återvinningsbar



Brett  
temperaturspann



Kemikalieresistens



Läcktestning



Logistiklösning



Anpassad för  
livsmedel



Enkel att  
rengöra

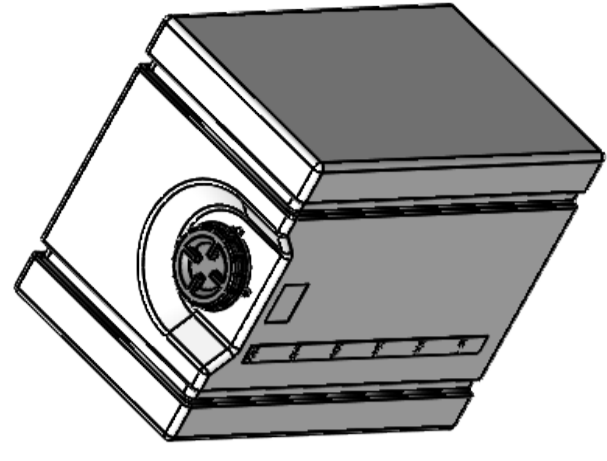
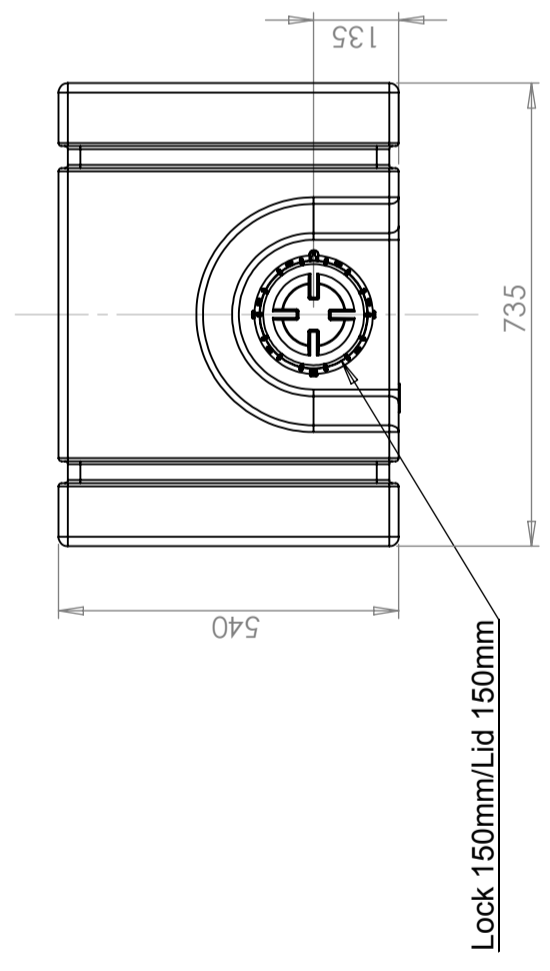
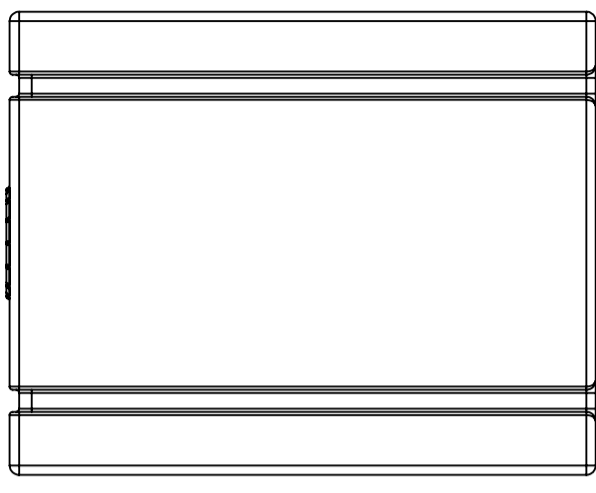
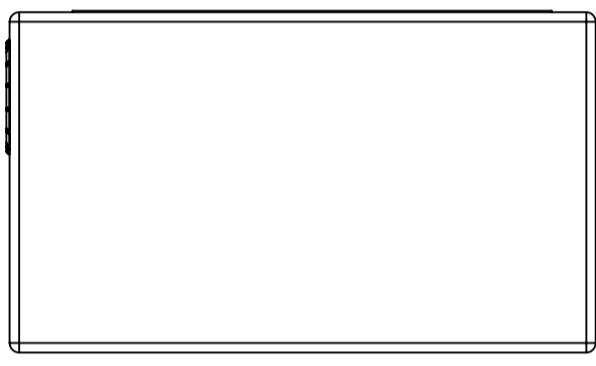
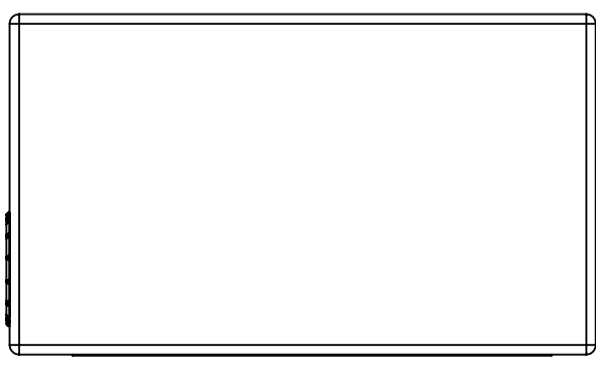
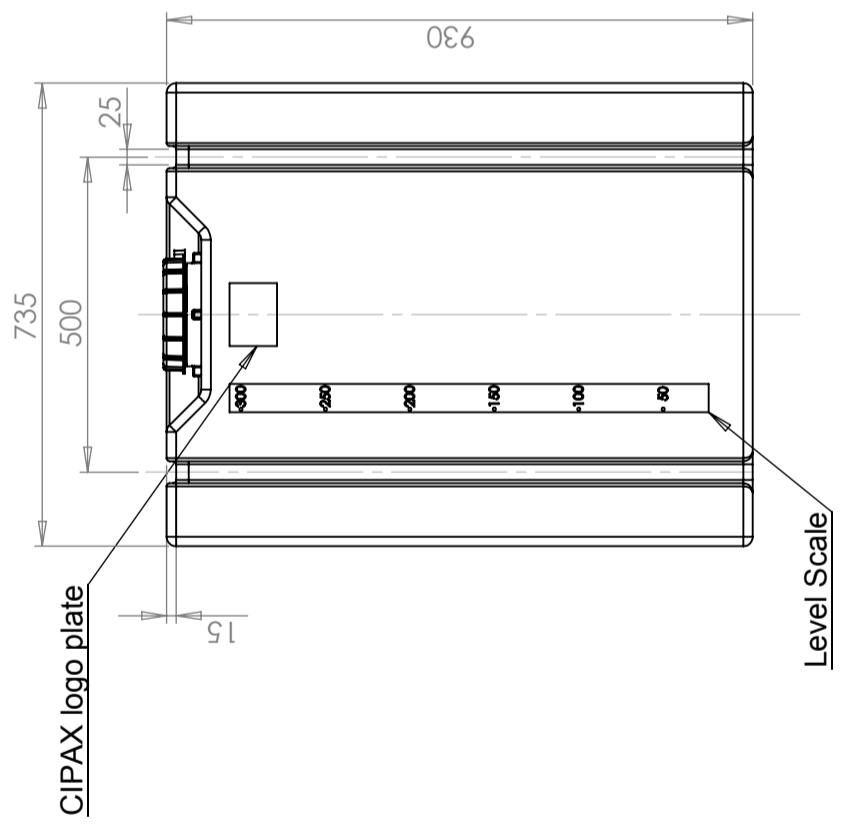
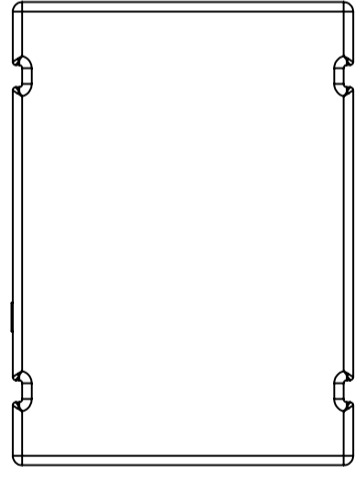

Material: polyethene, white

Konstruerad av	Granskad av	Godkänd av - datum	Generell tolerans	Generell Ytjämnhet, Ra	Vyplacering	Skala
JA	JA	JA - 2013-11-14	SS-ISO 2768-1			1:12

Ägare	Titel/Benämning	Blad
	Rektangulär behållare 310 L	1(1)
	Ritningsnummer	
	20310	
	Utgåva	



Generella toleranser om ej annat anges på ritning General tolerances if not other stated on drawing	Tillåtna avvikelser för längdbasmåttområde Permissible deviations for basic length size range	0-20	>20-75	>75-150	>150-300	>300
		± 0,5 mm	± 1 mm	± 1,5 mm	± 1,3 %	± 1 %

This drawing and design is the property of CIPAX. Copying and distribution of the drawing or any contents is prohibited without written permission from authorised personal at CIPAX