

CPX Silo 500L cylindrisk



Silo i rotationsgjuten polyeten, lämplig för användning i vattenbehandlings eller kemikalieindustrin, jordbruk och livsmedelsproduktion. Stativ i stål eller polyeten finns som tillbehör och säljes separat. Naturellt lock D500. Botten D200, kona 45°.

Art.nr: 40811



Kräver enkeldörr



Ungefärlig storlek

Specifikationer

Material	PE
Form	Cylindrisk
Bottenform	Konisk
Utförande	Öppen
Färg	Naturell
Volym (L)	500
Höjd (mm)	1470
Diameter (mm)	760
Vikt (kg)	22
Tullstatistiskt nummer	3925100000

Återvinning



Egenskaper



Brett
temperaturspann



Kemikalieresistens



Läcktestning



Logistiklösning



Anpassad för
livsmedel



Enkel att
rengöra

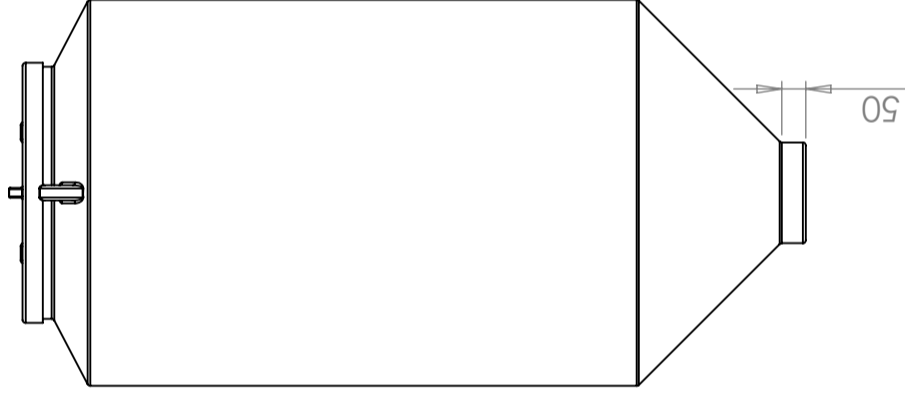
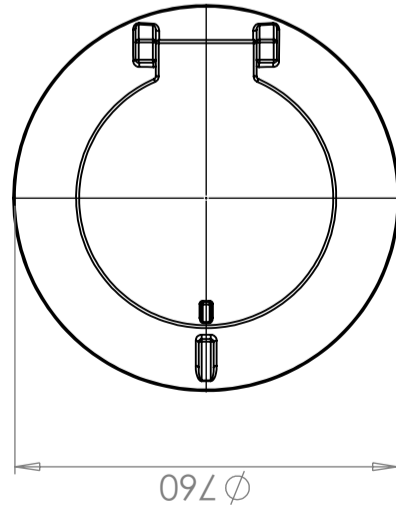
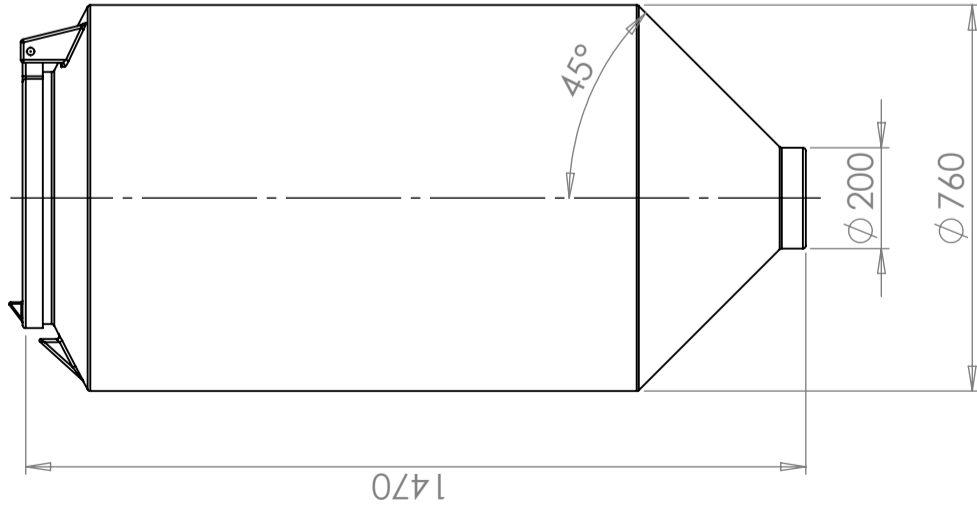
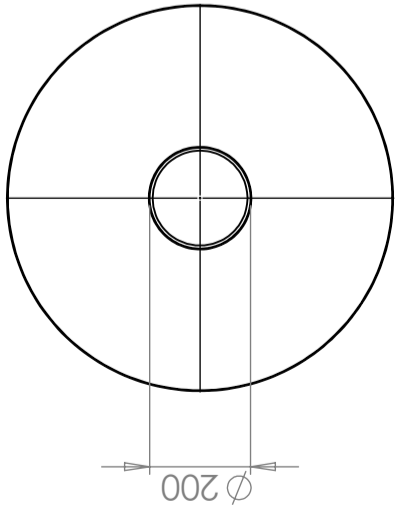

Revision

REV.

Ändringsmeddelande

Datum

Godkänd

This drawing and design is the property of CIPAX. Copying and distribution of the drawing or any contents is prohibited without written permission from authorised personal at CIPAX

Konstruerad av	Granskad av	Godkänd av - datum	Generell tolerans SS-ISO 2768-1	Generell Ytjämnhet, Ra	Vyplacering	Skala
		-				1:15
Titel/Benämning						
CPX Silo 500L cylindrisk						
Ritningsnummer						
40811						
Ägare						Blad
						A
						1(1)