

This drawing and design is the property of Cipax.
 Copying and distribution of the drawing or any contents
 is prohibited without written permission from authorised
 personal at Cipax

Revision			
REV.	Ändringsmeddelande	Datum	Godkänd

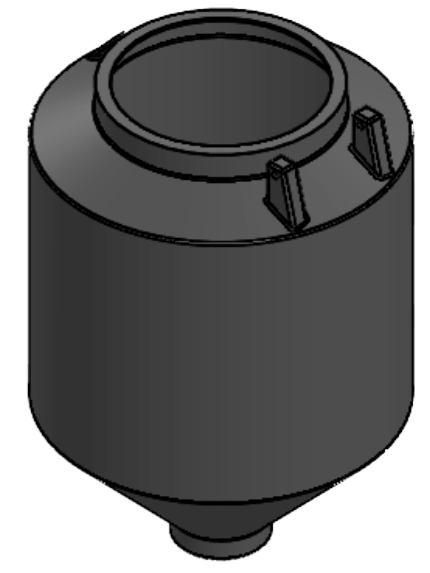
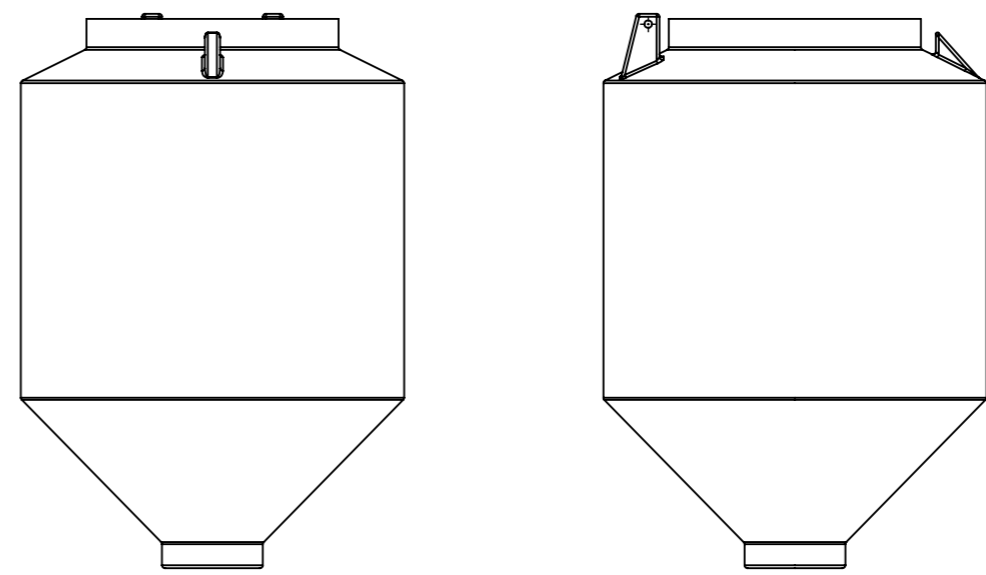
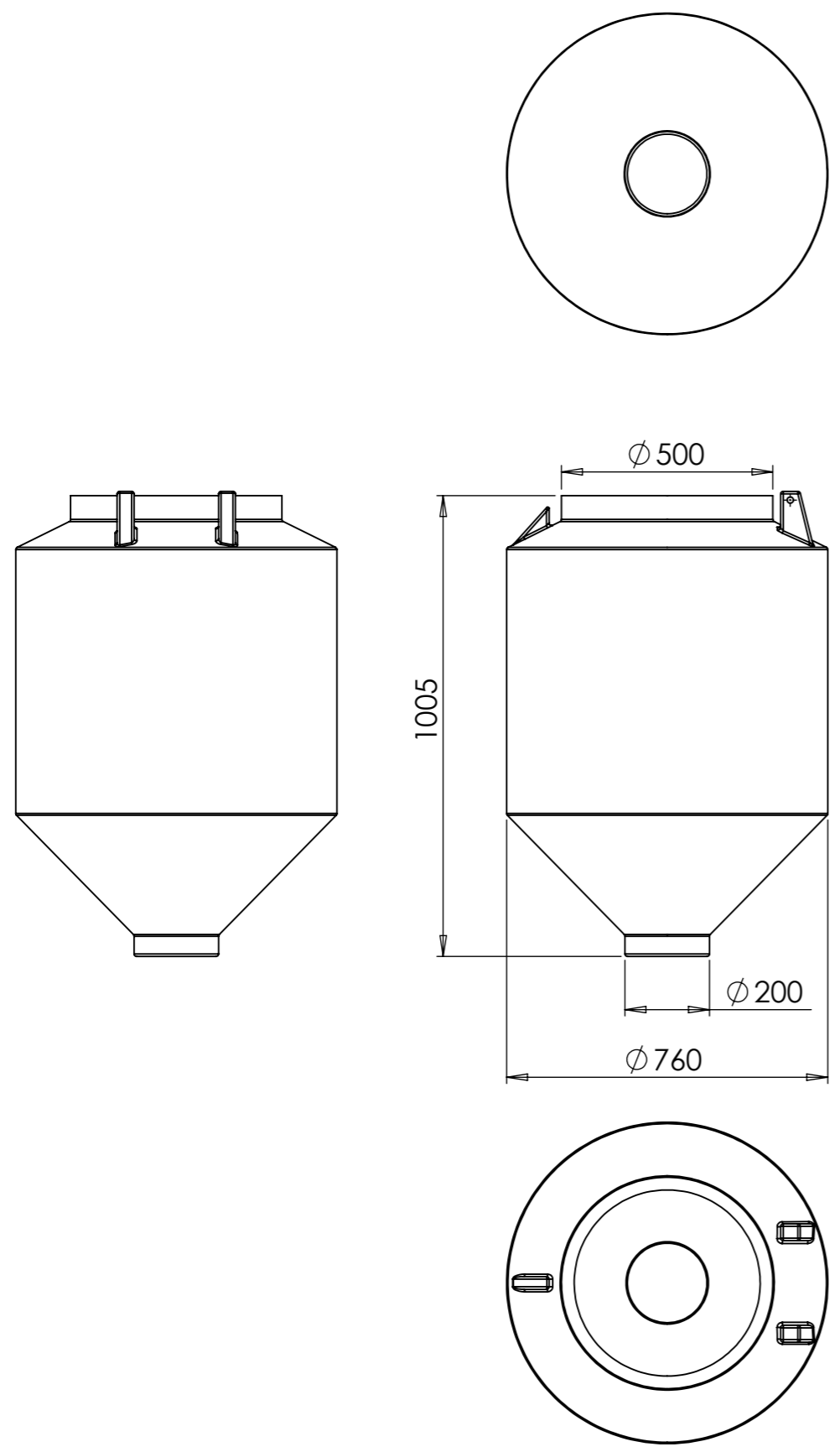

Konstruerad av	Granskad av	Godkänd av - datum	Generell tolerans SS-ISO 2768-1	Generell Ytjämnhet, Ra	Vyplacering	Skala
		-				1:15
Ägare		Titel/Benämning				
		CPX Silo 300L cylindrisk				
Ritningsnummer				Utgåva	Blad	
40802				A	1(1)	